



**C.R.B. KRZYSZTOF STROIŃSKI**

Al. Reymonta 23/246  
01-840 Warszawa  
NIP: PL 1230933581

biuro@krawezniki.waw.pl  
tel. +48 668 616 777  
tel. +48 22 112 16 36

[www.formowanieslizgowe.pl](http://www.formowanieslizgowe.pl)



# OFERTA OGÓLNA

**Firma C.R.B. Krzysztof Stroiński z siedzibą w Warszawie Al. Reymonta 23/246 ma przyjemność złożyć ofertę na wykonanie elementów betonowych metodą**

**Ciągłego Rozkładania Betonu.**



**Metodą CRB można formować następujące elementy:**

**Krawężniki**

**Ścieki**

**Krawężniki ze ściekiem**

**Ławy**

**Bariery ochronne**

**Brewki zabezpieczające skarpy i nasypy przed wymyciami**

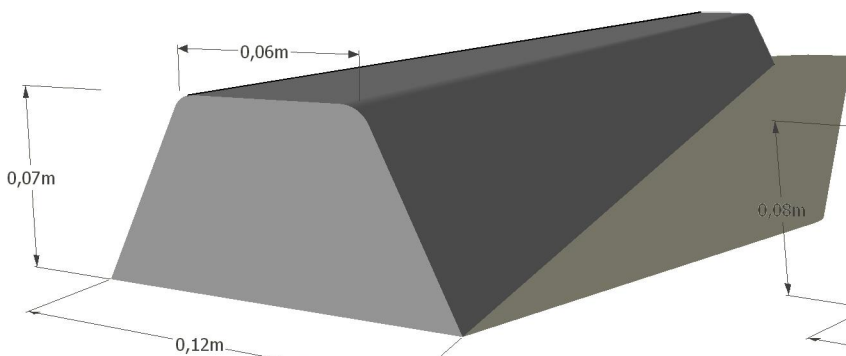

**brewka nr. 1**

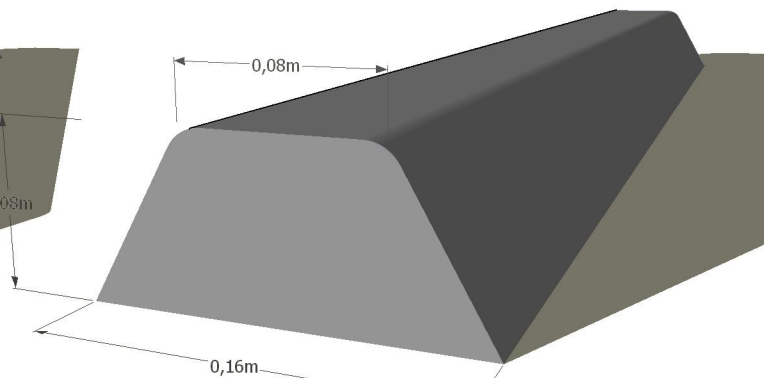

**brewka nr. 2**

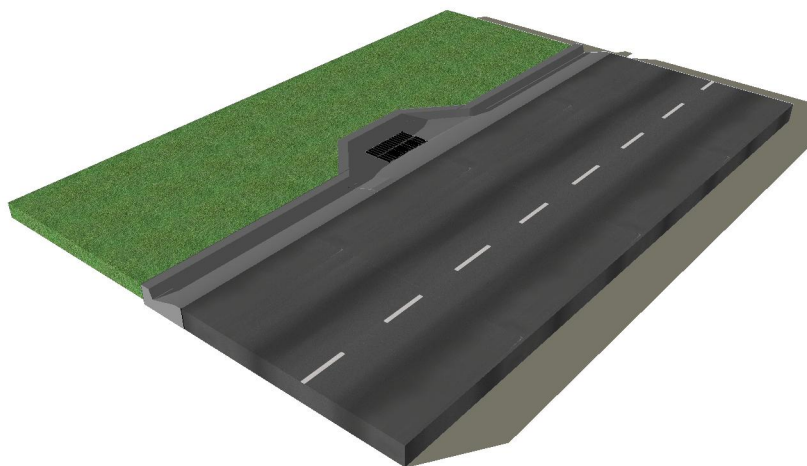

**przykład odwodnienia  
ścieku trójkątnego**

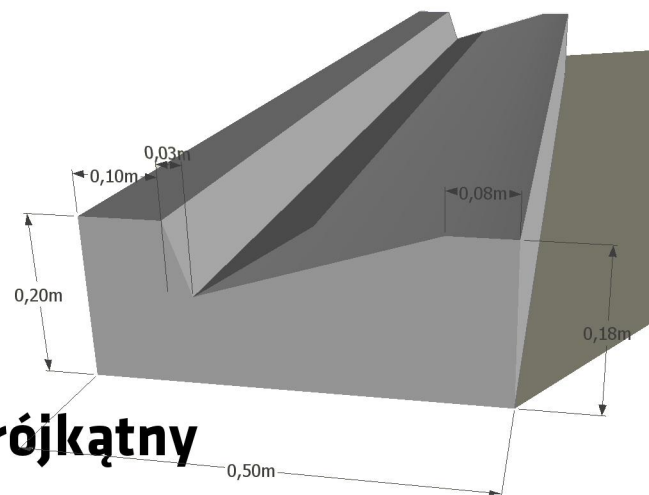

**ściek trójkątny**

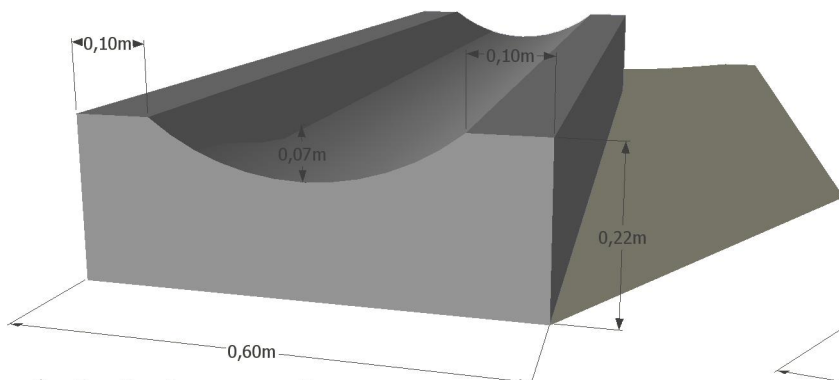

**ściek korytkowy**

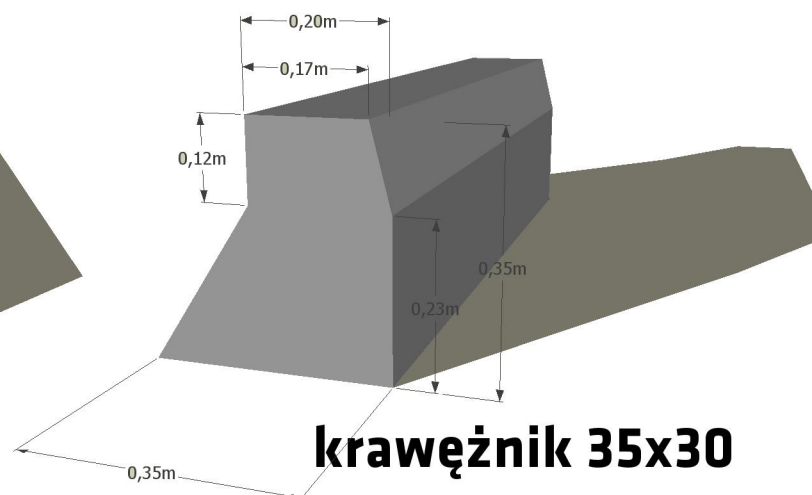

**krawężnik 35x30**

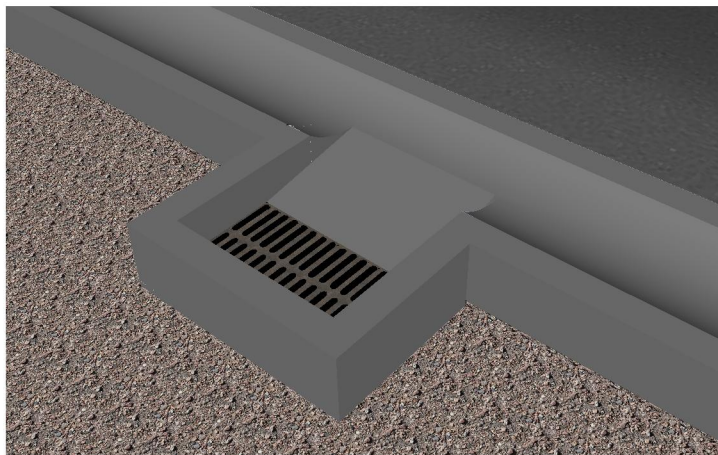
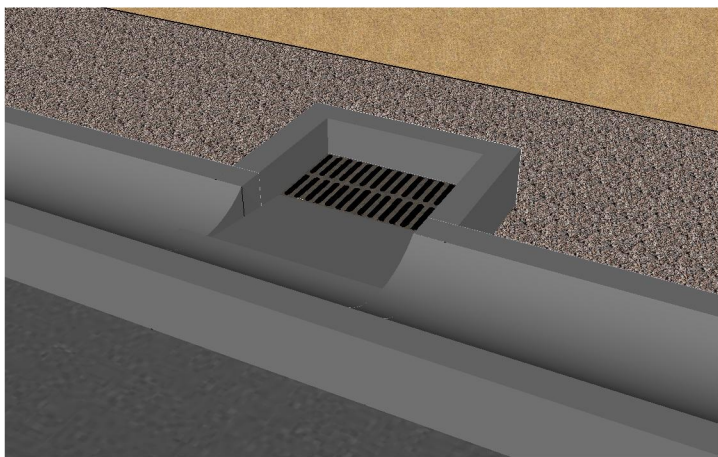

## Przykład odwodnienia ścieku korytkowego

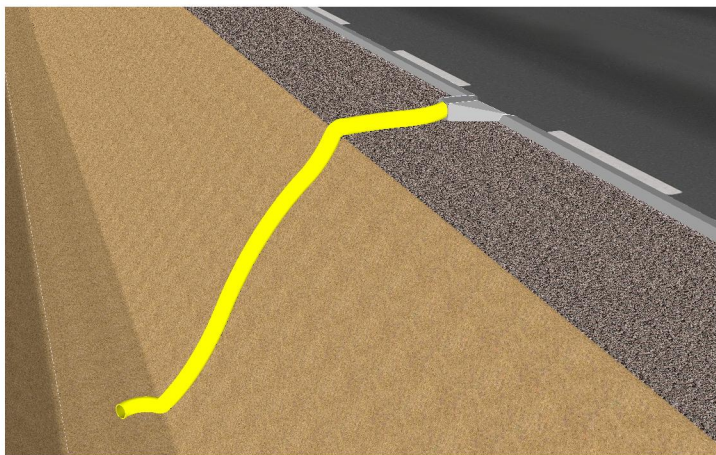
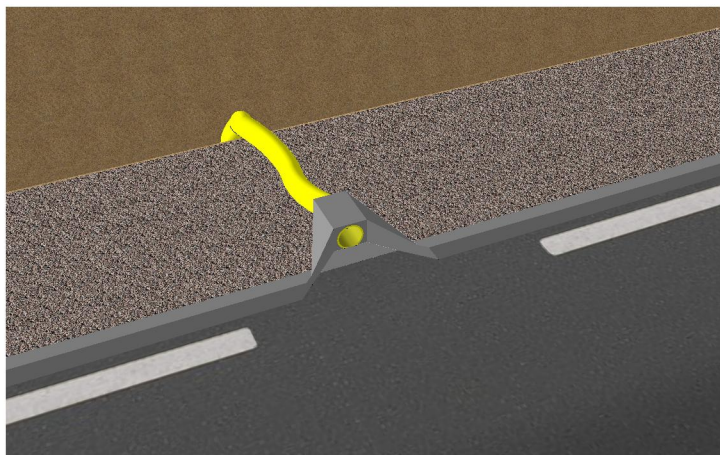

## Przykład odwodnienia brewki z rurą drenażową średnicy 10 cm.



**Metoda ciągłego rozkładania betonu pozwala na szybkie i bezproblemowe formowanie elementów betonowych od krawężników drogowych po dwumetrowe bariery bezpieczeństwa albo całe pasy nawierzchni betonowej. Wykonywanie elementów betonowych na miejscu wykonania pozwala nie tylko podnieść efektywność czasowo kosztową, ale również podnosi estetykę i trwałość elementów.**

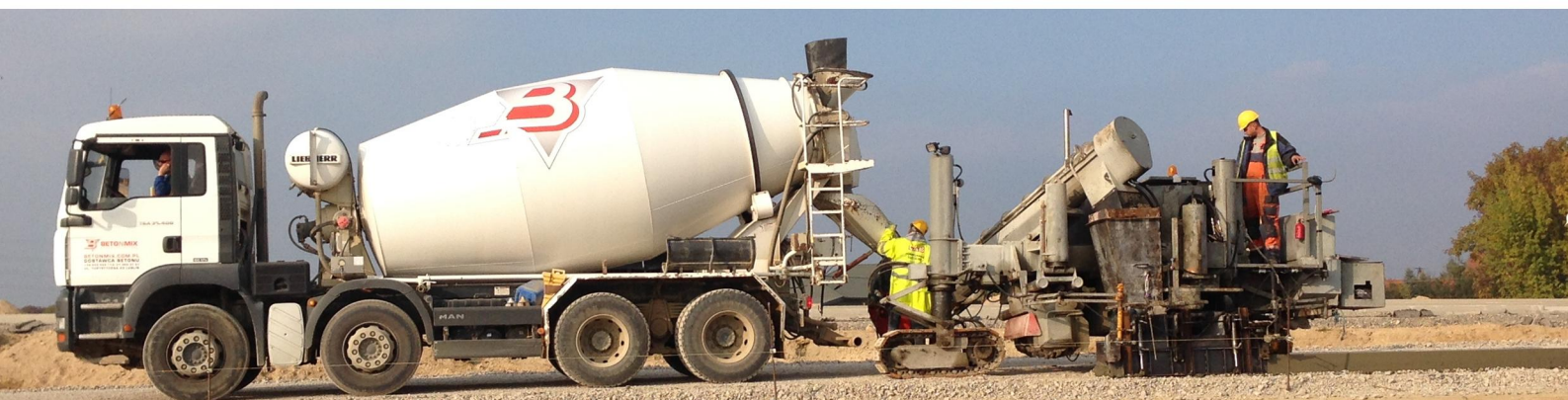

**Formowany metodą Ciągłego Rozkładania Betonu element może przyjmować różne, zależne od formy kształty a także być rozkładany wzdłuż łuków, dzięki czemu wykonywanie zatoczek, zjazdów czy wysepek nie stanowi najmniejszego problemu. Istnieje możliwość montażu zbrojeń w znakomitej większości rozkładanych elementów.**

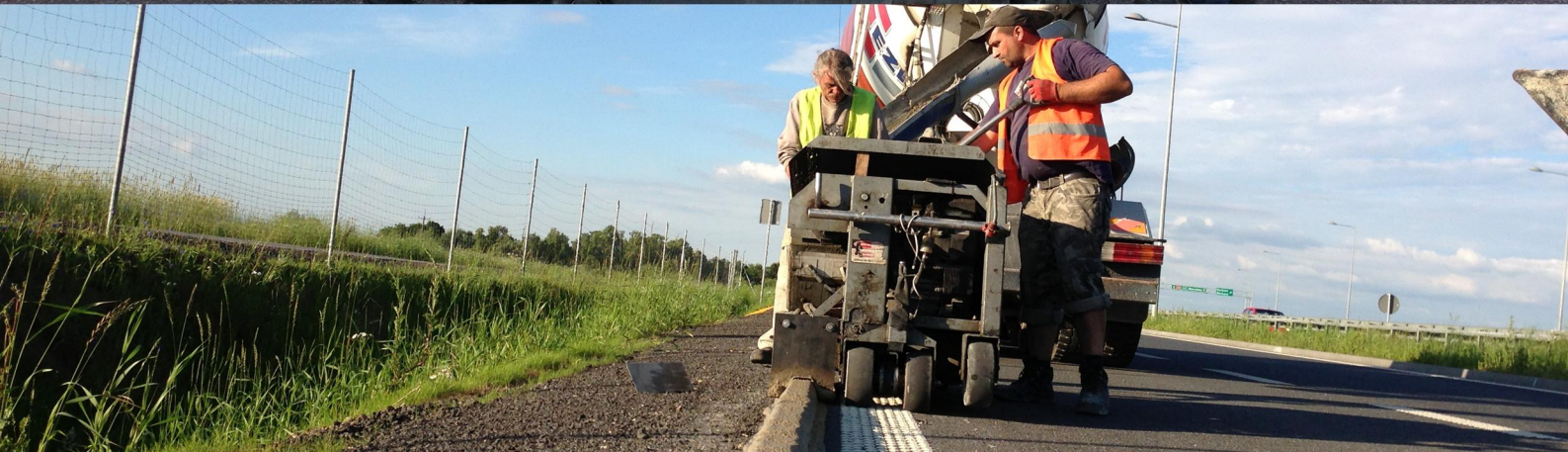

**Szczegóły oferty, ceny poszczególnych usług, możliwe terminy wykonania wymagają ustalenia z uwzględnieniem niezbędnych szczegółów. Celem uzyskania wszelkich dodatkowych informacji prosimy o kontakt.**



# NASZE PRZYKŁADOWE REALIZACJE

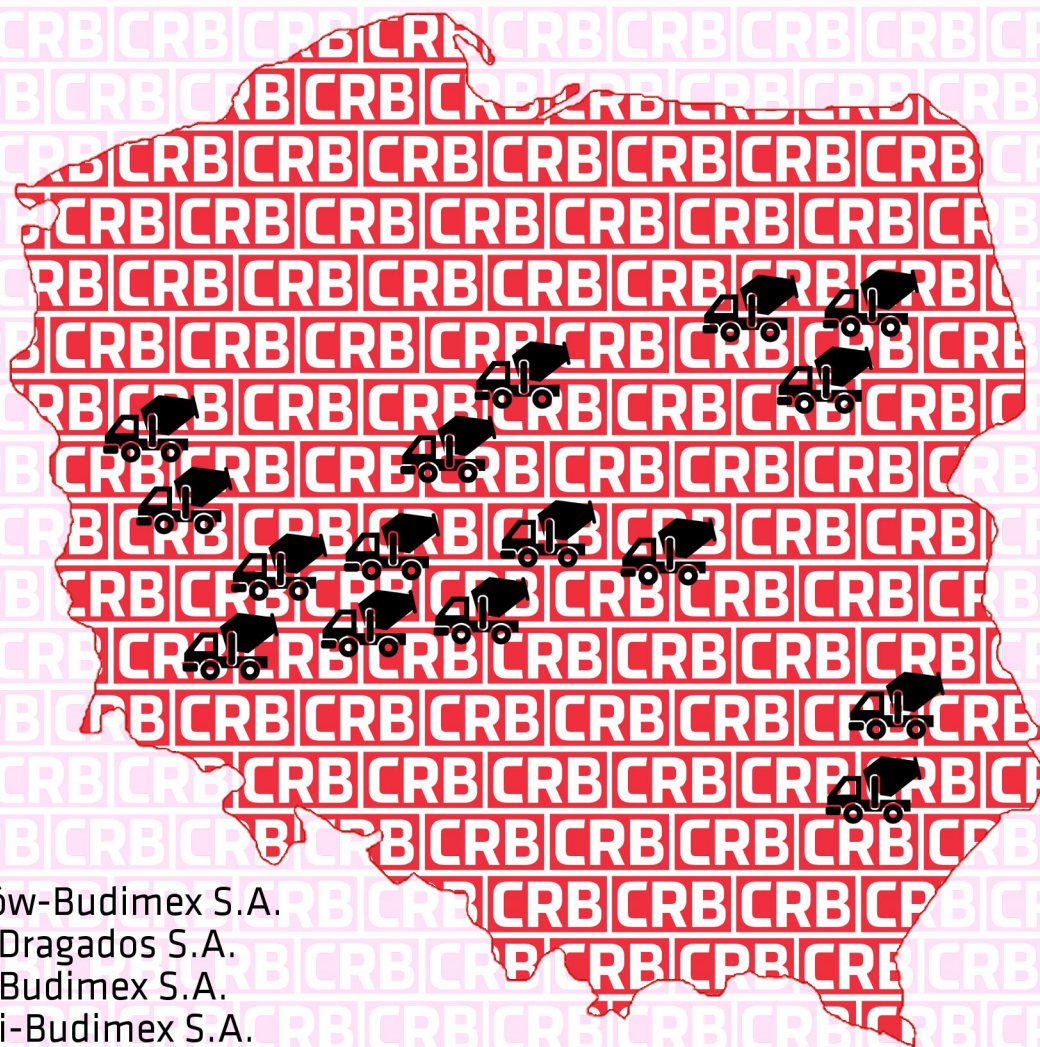

- S8 Augustów-Budimex S.A.
- S17 Lublin-Dragados S.A.
- S5 Rawicz-Budimex S.A.
- S8 Stawiski-Budimex S.A.
- S8 Bargłów Kościelny-PORR POLSKA S.A.
- A2 Wiskitki-Bogl A Krysl Sp. Z o.o.
- DW835 Wysokie-Strabag
- A1 Toruń-Kobylarnia S.A
- S8 Tomaszów Maz.-Astaldi
- A2 Łyszkowice-Eurovia
- A2 Skierniewice-Mostostal Warszawa
- A2 Mińsk Maz.-PBDiM Sp. Z o.o.
- S10 Bydgoszcz-Budimex S.A
- DK16 Biskupiec-PBDiM Sp. Z o.o
- A1 Kutno-Bogl A Krysl Sp. Z o.o.
- S3 Gorzów Wlkp.-Berge Bau Polska Sp. Z o.o





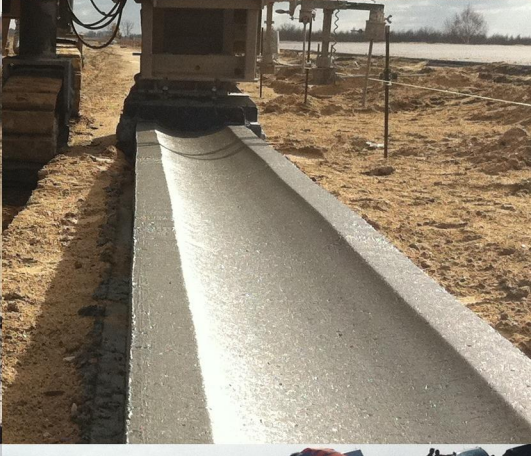
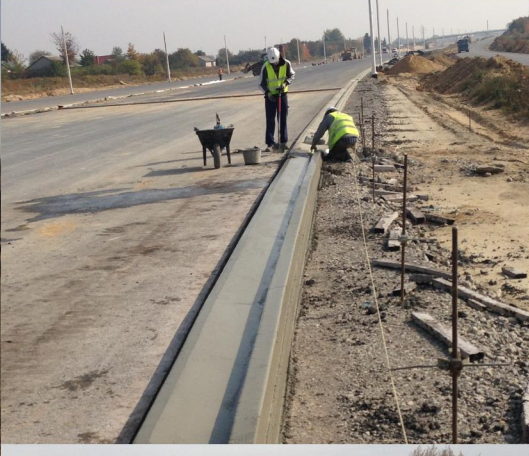

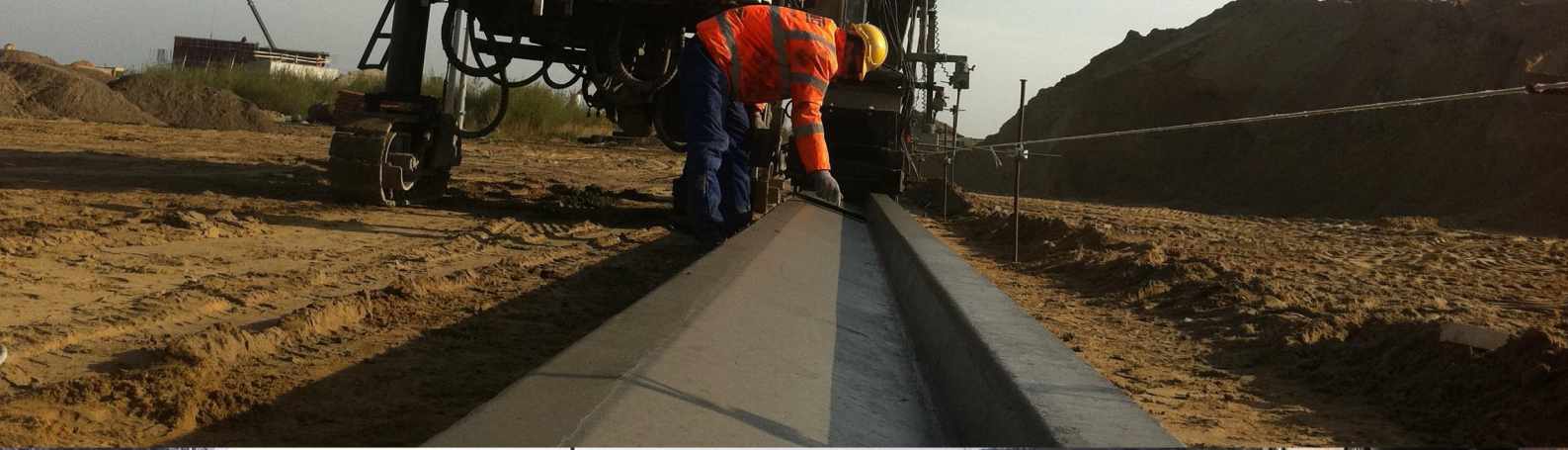

**Dziękujemy za zapoznanie się  
z naszą ofertą.**

**Zespół C.R.B**

